

MOTOR OPERATED VALVES

Pima Valve has set the standard for furnishing electric, hydraulic and pneumatic motor operated gate, globe and angle valves to U.S. shipbuilders. That is because of our product knowledge and attention to detail. Since every standard valve requires a predictable thrust and torque to seat or unseat against the differential pressure, certain data must be known. This data can be accumulated on the form following this page and then transmitted to our sales engineers who will calculate the torque requirement and properly size the operator. It is important that you choose a knowledgeable supplier at this point because an operator which is undersized will not perform to the specification requirements and, in fact, may not work at all. An oversized unit is not cost effective and can also cause system damage in extreme cases. Other potential problems to be aware of are the many option items required by the end user as they can have a very large impact on the efficiency of the unit, the delivery period and the cost. With Pima Valve, you can rest assured that your requirements are being handled by a experienced staff in motor actuation.

The following formulas and tables are used to properly size the operator:

$$\text{THRUST} = \Delta P \times \text{Seat Area} \times \text{FV} + \text{Stuffing Box Load}$$

$$\text{TORQUE} = \text{Thrust} \times \text{Stem Factor}$$

TABLE A

Valve Size	1-1/2"	2"	2-1/2"	3"	4"	5"	6"	8"	10"	12"	14"	16"	18"	20"	24"
Seat Area	1.77	3.14	4.91	7.07	12.57	19.64	28.3	50.3	78.5	113.1	153.9	201	254	314	452

TABLE B

Gate Valve Design	FV Factor
Solid Wedge	0.3
Split Wedge	0.3
Flexible Wedge	0.35
Parallel Seat Double-Disc	0.2
Globe or Angle Valve	1.1

TABLE C

Stem Diameter	Stuffing Box Load
Up thru 1"	1,000 Lb.
1-1/8" thru 1-1/2"	1,500 Lb.
1-5/8" thru 2-3/4"	2,000 Lb.

TABLE D

Stem Dia.	VALVE STEM LEAD										
	1/12"	1/6"	1/5"	2/5"	1/4"	1/2"	2/7"	4/7"	1/3"	2/3"	1"
1/2"	.006	.006	.006	.009	.007	.011	.008	.012	.008		
5/8"	.007	.007	.008	.010	.008	.012	.009	.013	.009		
3/4"	.009	.008	.009	.011	.009	.013	.010	.014	.010		
7/8"	.010	.009	.010	.012	.010	.014	.011	.015	.011		
1"	.012	.010	.011	.013	.011	.015	.012	.016	.012	.017	.023
1-1/8"	.013	.012	.012	.014	.012	.016	.013	.017	.013	.018	.024
1-1/4"	.014	.013	.013	.015	.014	.017	.014	.018	.014	.019	.025
1-3/8"	.016	.014	.014	.016	.015	.018	.015	.019	.015	.020	.026
1-1/2"	.017	.015	.015	.017	.016	.019	.016	.020	.017	.021	.027
1-5/8"	.018	.016	.016	.018	.017	.020	.017	.021	.018	.022	.028
1-3/4"	.020	.017	.017	.019	.018	.021	.018	.022	.019	.023	.029
1-7/8"	.021	.018	.019	.020	.019	.023	.019	.024	.020	.025	.030
2"	.022	.019	.020	.021	.020	.024	.020	.025	.021	.026	.031





**PIMA
VALVE, INC.**

**INFORMATION REQUIRED TO
QUOTE MOTOR OPERATORS**
Hydraulic... Electric...Pneumatic

Prepared by: _____ Date: _____

Final User: _____

VALVE DATA

Valve Size: _____	Valve Mfr: _____	Fig. No.: _____
Valve Type: <input type="checkbox"/> Gate (<input type="checkbox"/> OS&Y <input type="checkbox"/> NRS) <input type="checkbox"/> Globe		
Valve Stem Diameter: _____		
Valve Stem Pitch: _____		Lead: _____
Stem Thread: <input type="checkbox"/> Left <input type="checkbox"/> Right		
Stem Travel: _____		
Time To Operate (Full Close to Open): _____		
Maximum Differential Pressure: _____		
Thrust: _____		Torque: _____
Stem Protector: <input type="checkbox"/> Yes <input type="checkbox"/> No		

HYDRAULIC MOTOR OPERATOR

Motor Housing Material: <input type="checkbox"/> Ductile Iron <input type="checkbox"/> Aluminum
Hydraulic System Working Pressure: _____ PSI
Hydraulic System Flow Rate: _____ GPM
Motor Port Connections: _____
Handwheel: <input type="checkbox"/> Spoked <input type="checkbox"/> Dished Material: _____

ELECTRIC MOTOR OPERATOR

Electric Motor: <input type="checkbox"/> Weather Resistant <input type="checkbox"/> Submersible <input type="checkbox"/> Explosion Proof
Power Supply: Volts _____ Phase _____ Cycle _____ Volts DC _____
Control Voltage: Volts _____ Phase _____ Cycle _____
<input type="checkbox"/> Local Dial Position Indicator <input type="checkbox"/> Remote Potentiometer Type PI <input type="checkbox"/> Transformer
<input type="checkbox"/> Space Heater Required <input type="checkbox"/> Breather & Drain
Reverse Starter: <input type="checkbox"/> Integral <input type="checkbox"/> Separate <input type="checkbox"/> Mil-Spec Required
Connectors: <input type="checkbox"/> Power <input type="checkbox"/> Control
Control Station: <input type="checkbox"/> Remote <input type="checkbox"/> Integral <input type="checkbox"/> Pushbutton <input type="checkbox"/> Lights

AIR OPERATED

Pressure of Compressed Air Supply: _____
Method of Control: _____
Control Accessories: _____

SHOCK **VIBRATION REQUIRED?**



REPRESENTATIVE THRUST/TORQUE VALUES

BRONZE GATE VALVES (250 LB) MIL-V-1189, Ty.I, CL.II (803-2177917) STEM DATA

	2-1/2	3	4	5	6	8	10	12
Stem Diameter	3/4	3/4	7/8	1	1	1-1/4	1-3/8	1-1/2
Stem Pitch	1/6	1/6	1/6	1/4	1/4	1/4	1/4	1/4
Stem Lead	1/3	1/3	1/3	1/2	1/2	1/2	1/2	1/2
Travel	2-11/16	3-1/4	4-7/16	5-3/8	6-3/8	8-7/16	10-7/16	12-7/16

Pounds of Thrust @ $\Delta P100$	1147.30	1212.10	1377.10	1589.20	1849.00	3009.00	3855.00	4893.00
Foot Pounds of Torque @ $\Delta P100$	11.47	12.12	15.15	23.84	27.74	51.15	69.39	92.97

Pounds of Thrust @ $\Delta P170$	1250.41	1360.57	1641.07	2001.64	2442.28	4063.26	5505.54	7263.00
Foot Pounds of Torque @ $\Delta P170$	12.50	13.61	18.05	29.42	35.90	68.47	98.27	137.27

Pounds of Thrust @ $\Delta P250$	1368.25	1530.25	1942.75	2473.00	3121.00	5269.50	7390.50	9975.00
Foot Pounds of Torque @ $\Delta P250$	13.68	15.30	21.37	36.35	45.88	88.79	131.92	188.53

All Valves are Double Lead, Left Hand.



GATES WITH OPERATORS

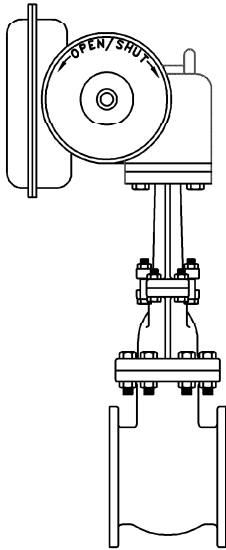

WITH
ELECTRIC
OPERATOR

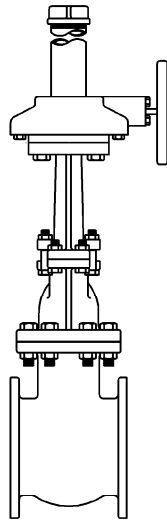

WITH
BEVEL
GEAR

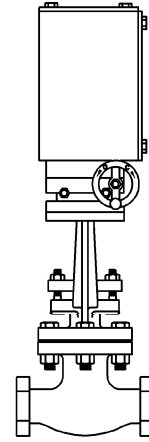

WITH
ELECTRIC
OPERATOR

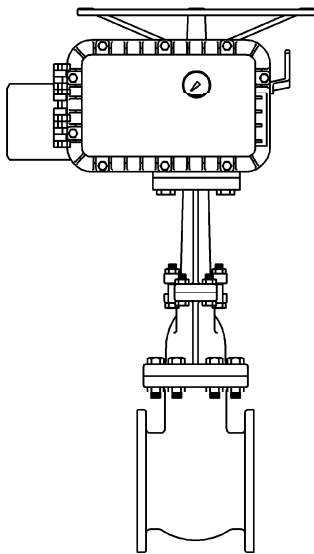

WITH
ELECTRIC
OPERATOR

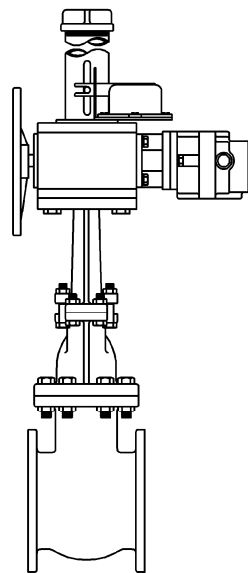

WITH
HYDRAULIC
OPERATOR

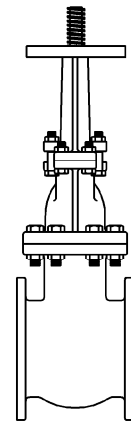

TO ACCEPT
ELECTRIC OR
HYDRAULIC



GLOBES WITH OPERATORS

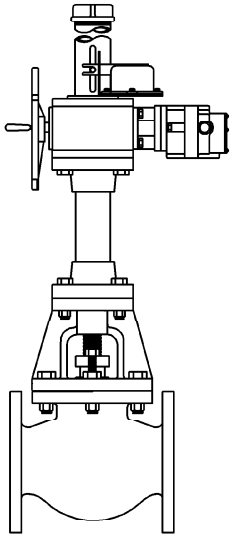

WITH
HYDRAULIC
OPERATOR

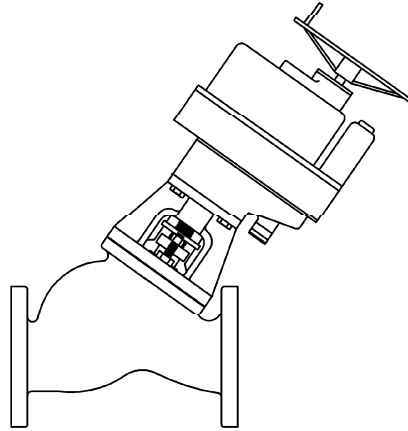

WITH
ELECTRIC
OPERATOR

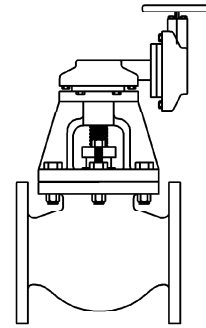

WITH
BEVEL
GEAR

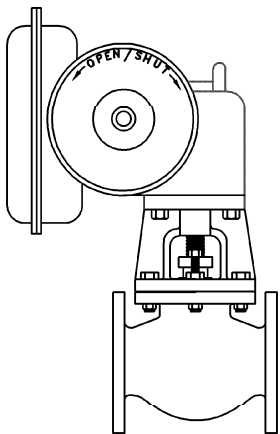

WITH
ELECTRIC
OPERATOR

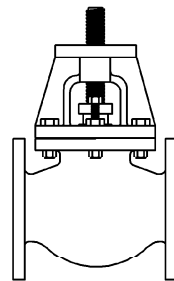

TO ACCEPT
ELECTRIC OR
HYDRAULIC

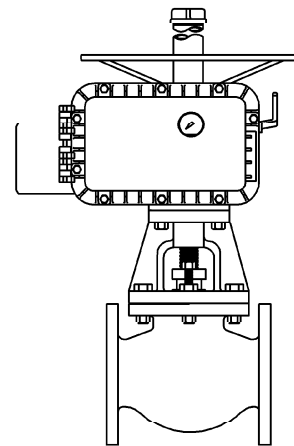

WITH
ELECTRIC
OPERATOR



ANGLES WITH OPERATORS

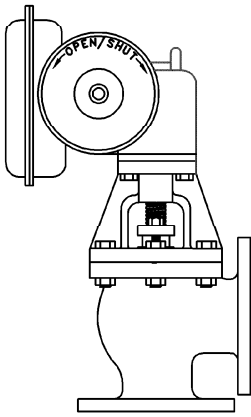

WITH
ELECTRIC
OPERATOR

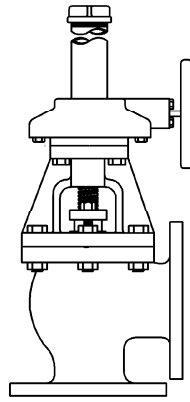

WITH
BEVEL
GEAR

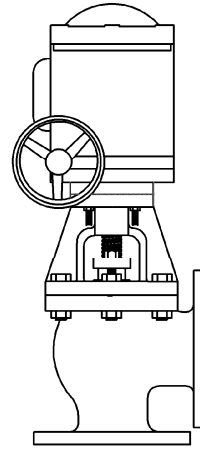

WITH
ELECTRIC
OPERATOR

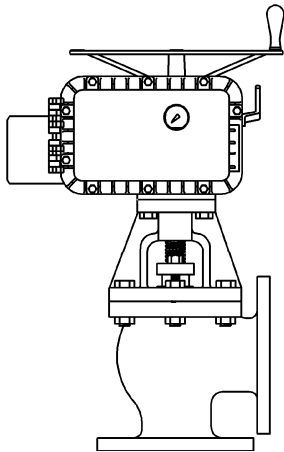

WITH
ELECTRIC
OPERATOR

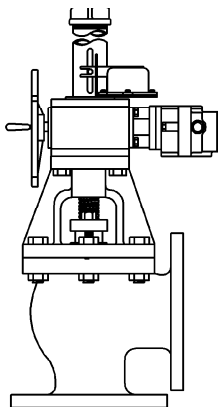

WITH
HYDRAULIC
OPERATOR

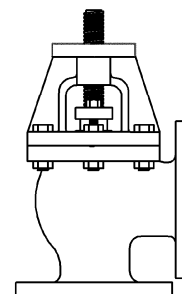

TO ACCEPT
ELECTRIC OR
HYDRAULIC

